

ZELIG

Uno dei best-seller della produzione Bettio, la soluzione ideale per chi preferisce un prodotto elegante ed universale.

- Design arrotondato, stile contemporaneo ed elegante
- Grande versatilità tecnica
- Ottimo per proteggere tutti gli ambienti della casa con un unico prodotto, indipendentemente dalle caratteristiche dei fori



Movimento verticale e orizzontale



Installazione in foro, frontale e incasso



Con comando a molla o con catena



Cassonetto 42 mm

COLORI ACCESSORI IN PLASTICA



Bianco















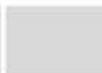

















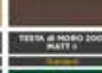

Nero



Bronzo

Colori alluminio



Frizione di Sicurezza



Consente alla zanzariera di riavvolgersi gradualmente evitando pericolosi urti derivanti dalla perdita di controllo della barra maniglia!

- 1 SQUADRETTE DI FISSAGGIO**
Le squadrette possono essere fissate al cassonetto o alle testate, offrendo un'alternativa alle installazioni classiche.
- 2 CUFFIE TELESCOPICHE**
Grazie a questo accessorio è possibile correggere i fuori squadra fino a 10mm.
- 3 GUIDE AD INCASSO**
Zelig può essere incassata utilizzando una delle guide ad incasso a disposizione, una delle quali con percorso per la tapparella.
- 4 MOVIMENTO CON CATENA**
Versione straordinaria di Zelig, che include tutte le migliori tecnologie Bettio: Clic-Clak®, molla di richiamo, zavorre, possibilità di inserire la catena dove si preferisce, testate interne o esterne ed ovviamente le rinomate guide antivento.
- 5 ATTACCO FRONTALE**
Anche questo tipo di installazione ha molteplici varianti, dalla barra maniglia allo zoccolo interno regolabile.
- 6 CLIC-CLAK®**
Nasce con Zelig questo pratico e funzionale metodo di aggancio della barra maniglia.



Accessori rappresentati in colore nero a scopo puramente illustrativo



REGOLAZIONI:
+10mm mediante cuffie telescopiche



APPLICAZIONE CONSIGLIATA:
Porta e finestra



Chiusura con calamita



Applicazione con clips



Guida doppia ad incasso

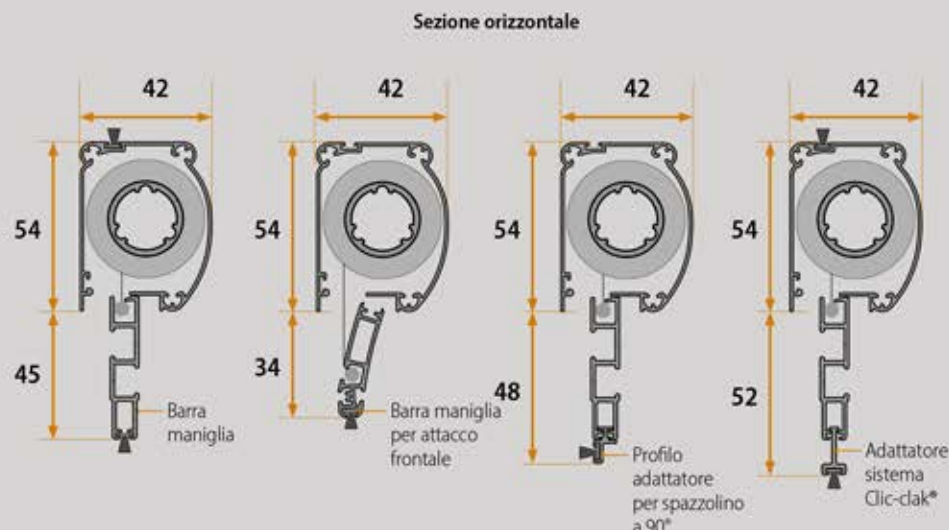
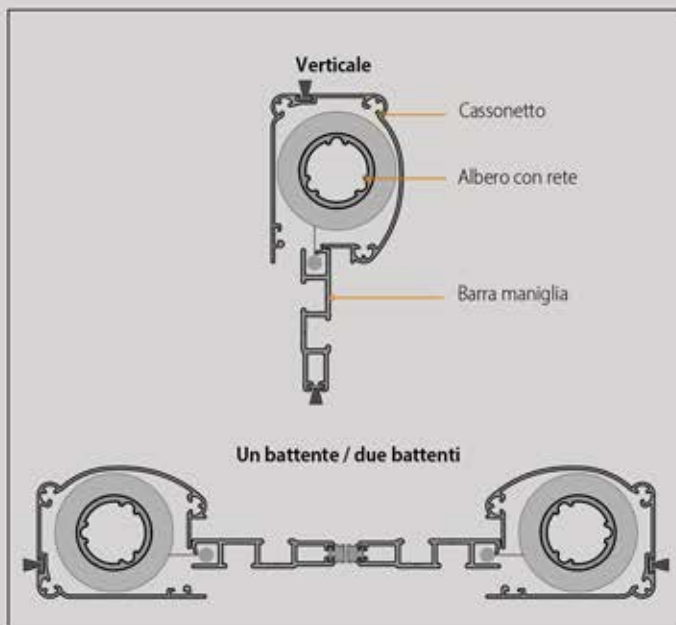

AGGANCIO CLIC-CLAK®

A CATENA

ATTACCO FRONTALE

UN BATTENTE

DUE BATTENTI



Accessori rappresentati in colore nero a scopo puramente illustrativo



PORTA E FINESTRA
 Minimo: **550b x 700h mm**
 Massimo: **2000b x 2480h mm**
 (Con frizione: base minima di 700 mm)



UN BATTENTE
 Minimo: **700b x 960h mm**
 Massimo: **1600b x 2480h mm**
 (Con frizione: altezza minima di 1100 mm)



DUE BATTENTI
 Minimo: **1400b x 960h mm**
 Massimo: **3200b x 2480h mm**
 (Con frizione: altezza minima di 1100 mm)